

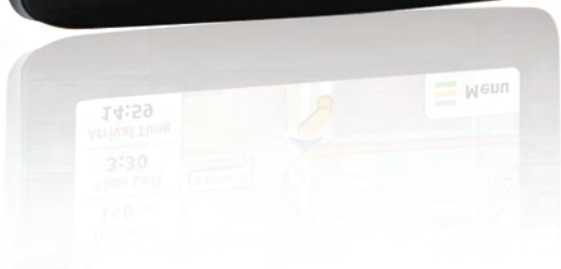

ITEM# 43LT



nextar  TM
AUTOMOTIVE NAVIGATION SYSTEM (GPS)

HARDWARE INSTRUCTION MANUAL

Introduction

Congratulations on purchasing your Nextar GPS Navigator. Your mobile navigation system assures that your days of getting lost are over! Finding an address or any of millions of different points of interest such as the nearest gas station or restaurant is a snap anywhere across the U.S. Just enter information using the touch screen and let the voice prompt and detailed map guide you to your destination. Your navigator also includes lifetime Live Traffic to alert you of traffic problems in major metropolitan areas across the US.

Important Safety Information

Read and keep these instructions

Failure to heed the following warnings could result in an accident or collision resulting in serious injury or death

- When installing the unit in a vehicle, place the unit so that it does not obstruct the driver's view of the road or interfere with vehicle operating controls.
- This GPS unit is designed to provide you with route suggestions. It does not reflect road closures or road conditions, traffic congestion, weather conditions, or other factors that may affect safety or timing while driving.
- Always operate the vehicle in a safe manner. Do not become distracted by the unit while driving. The directions provided by the navigation unit are not guaranteed to be accurate in every situation. Before following suggestions from the unit, use your best judgment regarding the safety and legality of any action you take with your vehicle.
- Use this GPS unit only as a navigational aid. Do not attempt to use the unit for any purpose requiring precise measurement of direction, distance, location, or topography. This product should not be used to determine ground proximity for aircraft navigation.
- Do not access the GPS functions while driving. Pull over in a safe and legal manner before changing settings, entering destinations, or to access any other operational functions.
- Never store your GPS in temperatures less than -5°F or greater than 120°F.
- This unit contains a non-user-replaceable lithium-ion battery. Do not dispose of your GPS by fire or with hazardous or flammable materials. Contact your local waste disposal department for information regarding proper disposal of lithium-ion batteries.

Important Safety Information

- When in a car, do not mount your GPS on or near an air bag. If the air bag is deployed, you may be seriously injured.
- Only use a power cord and live traffic receiver provided by NEXTAR. Use of products provided by other suppliers may void the warranty.
- Caution: To reduce the risk of electric shock, do not remove cover or back. No user serviceable parts inside. Refer servicing to qualified service personnel.
- Do not use harsh chemicals (such as alcohol, benzene, thinners, etc.) or detergents to clean your GPS. This could damage the unit or cause a fire.
- Do not drop, strike, or shake your GPS severely. It may harm the internal electronics of the unit.
- Warning: To reduce the risk of fire, electric shock or damage, do not expose this product to rain or moisture. Do not use your GPS in high explosive areas as the unit may generate sparks.
- Do not damage the power cord by bending, twisting, pulling, or heating. Do not use the plug if it is loose as it may cause a fire or electric shock. Do not place any heavy items on the power cord. Do not allow the power cord to be crimped as it may cause electric shock or fire.
- Do not handle the GPS with wet hands while it is being charged. It may cause an electric shock or seriously damage your GPS.
- Spilled beverages are a common problem in moving vehicles. Do not locate liquid containers, or items that can accumulate condensation such as cold beverages, in a position where liquid can spill or drip on the GPS device.
- Only use attachments / accessories specified by the manufacturer.
- Unplug this device during lightning storms or when unused for long periods of time.
- Refer all servicing to qualified service personnel. Servicing is required when the apparatus has been damaged in any way, such as power-supply cord or plug is damaged, liquid has been spilled or objects have fallen into the apparatus, the apparatus has been exposed to rain or moisture, does not operate normally, or has been dropped.
- Caution: Dashboard temperatures can reach 180°F in a closed vehicle! To prevent the GPS from being damaged by excess heat, always **remove your GPS unit from the dash area when the car is parked.**

Important Safety Information

Important: Some states have restrictions on locating your GPS unit on the windshield. Included with your Nextar unit is an adhesive backed Dashboard Mount Disk that can be used if attaching the mounting bracket to the windshield is inconvenient or not allowed. See Page 12 for details.

Live Traffic Service

Your Nextar GPS unit comes with lifetime Live Traffic service that provides you with information about traffic events and traffic flow that may affect your route or driving time.

Important: In order for your GPS unit to receive and display traffic information, you must first connect the supplied FM receiver and antenna to your unit. See Page 9 for detailed instructions on installing the receiver and antenna in your vehicle. Refer to your Quick Start Guide or software guide for more information about Live Traffic Service.

FCC & UL Compliance

FCC COMPLIANCE:

This device complies with part 15 of the FCC Rules. Operation is subject to the following two conditions:

- This device may not cause harmful interference.
- This device must accept any interference received, including interference that may cause undesired operation.

This equipment has been tested and found to comply with limits for Class B digital device, pursuant to part 15 of the FCC Rules. These limits are designed to provide reasonable protection against harmful interference in a residential installation. This equipment generates, uses and can radiate radio frequency energy and, if not installed and used in accordance with the instructions, may cause harmful interference to radio or television reception, which can be determined by turning the equipment off and on, the user is encouraged to try to correct the interference by one or more of the following measures:

- Reorient or relocate the receiving antenna.
- Increase the separation between the equipment and the receiver. Connect the equipment into an outlet on a circuit different from that to which the receiver is connected.
- Consult the dealer or an experienced radio/TV technician for help.

CAUTION:

Underwriters Laboratories Inc. ("UL") has not tested the performance or reliability of the Global Positioning System ("GPS") hardware, operating software or other aspects of this product. UL has only tested for fire, shock or casualty hazards as outlined in UL's Standard(s) for Safety.

UL Certification does not cover the performance or reliability of the GPS hardware and GPS operating software.

UL MAKES NO REPRESENTATIONS, WARRANTIES OR CERTIFICATIONS WHATSOEVER REGARDING THE PERFORMANCE OR RELIABILITY OF ANY GPS RELATED FUNCTIONS OF THIS PRODUCT.

Table of Contents

Introduction

Important Safety Information	1
FCC & UL Compliance	4

Getting Familiar With Your Hardware

Main Unit	6
Accessories	7
Power Adaptor	8
Live Traffic Receiver	9
System Connections	10
Using the Mounting Bracket	12

Using Your Navigator

General Setup	13
Playing Music	18
Photo Viewer	20

Service & Support

Troubleshooting	23
Specifications	25

Main Unit

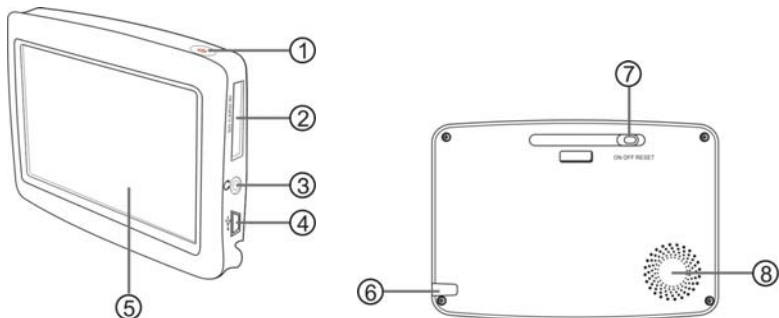

1. **POWER Button**
Press and hold for 2 seconds to enter or exit standby mode.
2. **Card Slot**
Insert the SD card into the slot.
Used for Mapping Data card or user's music or photo SD card
3. **Earphone Jack**
Connect user supplied earphone for private listening.
When an earphone jack is plugged in, the speaker will be turned off automatically.
4. **USB Port**
Connect to the FM Traffic Receiver or directly to the Power Adaptor to charge the unit.
5. **LCD Screen**
Tap the screen with a finger to select commands or use the included stylus
6. **Stylus**
7. **ON/OFF RESET Switch**
Used to switch power on or off.
8. **Speaker**

Accessories

The Following Items Are Included With Your GPS Unit

	<p>Instruction Manual Quick-Start Guide Warranty Card</p>
	<p>Live Traffic Receiver / Antenna</p>
	<p>Vehicle Power Adaptor</p>
	<p>Suction-Cup Mounting Bracket</p>
	<p>Mounting Cradle</p>
	<p>Stylus</p>
	<p>Dashboard Mount Disk</p>
	<p>Mapping Data SD Card</p>

NOTE: The SD card may be shipped installed in the GPS Unit.

See Page 9 for installation of the Live Traffic receiver and antenna

Power Adaptor

Using the Power Adaptor

The GPS unit is supplied with a DC Power Adaptor for charging the internal battery and for powering the unit while in a vehicle.

Connect the Power Adaptor USB plug to the unit's USB port and plug the other end to the vehicle's 12V accessory/ cigarette socket. Refer to instructions on the next page on how to connect the Live Traffic FM receiver if you desire to receive Live Traffic Data.

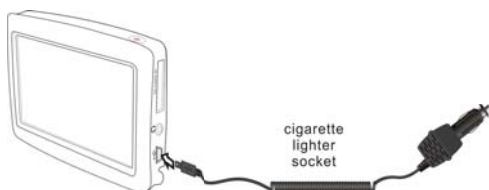

Attention

- Set up your destination and other settings before moving out into traffic. Do not access the controls of the GPS unit while driving.
- Mount the unit so that it does not obstruct your view of the road.

About Rechargeable Battery

Your portable GPS device comes with a built-in rechargeable Lithium-Ion battery. Charge the battery fully before initial use. Charging time is normally about 3.5 hours. A fully charged battery delivers about 2 hours of use. It is recommended to use the Power Adaptor while in the vehicle.

Working conditions and precautions for the rechargeable battery

- Battery should only be used and charged when temperatures are between 32°-100°F.
- Maintain well-ventilated conditions around the product to avoid overheating. Do not put the product on a blanket, clothing or anything that may block ventilation to the product.
- When the battery is weak, an indication symbol will appear on the LCD screen and the unit will power off automatically after a few minutes.

Live Traffic Receiver

Connecting to Live Traffic

The Traffic Message Channel (TMC) is an application of the FM Radio Data System (RDS) used for broadcasting real-time traffic information. Traffic data is received, decoded, and delivered to your navigation system. Nextar provides you with a separate FM receiver and antenna to pick up these signals; it is not connected in any way to your vehicle radio. This provides you with live traffic information – alerting you to a problem on your planned route.

Coverage of the Service

TMC Services cover major metropolitan areas across the US. TMC Service provides traffic information for monitored roads only, motorways and main roads. TMC radio transmission reception can change from area to area, depending on weather conditions, static electricity, power lines, and other natural or man-made conditions.

Connecting the TMC Receiver and Antenna.

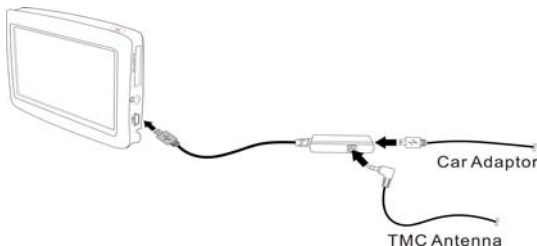

1. Connect the TMC receiver to the right side of the GPS unit in the USB port.
2. Connect the TMC antenna to the TMC receiver.
3. Place the wired antennas horizontally in the car using the rubber suction cups provided. It is recommended that the antenna be attached to the windshield.
4. Connect the Car Power Adaptor to the TMC receiver's USB port and plug the other end to the vehicle's 12V accessory / cigarette socket.

For more information on using Live Traffic, please refer to the Quick Start Guide or the software manual.

System Connections

Inserting SD Card

The unit is designed with an SD Card slot which allows you to insert an SD card into the unit as shown below:

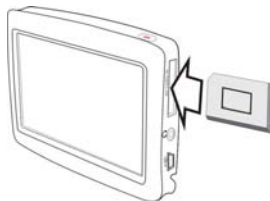

To remove the card, gently press the card in with your fingernail. The card unlocks and protrudes slightly. You can now remove the card. To re-insert the card, press the card in the slot until it clicks. The card should not protrude from the slot when it is installed correctly.

Important: If you remove the SD Mapping Data Card to use the Music or Photo functions, treat the Mapping Card very carefully to avoid damage or loss of data.

Connecting to Earphones

You may connect earphones to the right side of the unit for private listening.



When earphones are connected, the speaker will automatically turn off.

- **Note:** Overly loud volume could damage your hearing. Turn down the volume before you connect the earphones, and then raise the volume to a comfortable level.
- **Important:** Most state and local laws prohibit the driver from wearing earphones while operating a vehicle on public roads.

System Connections

USB Mode

When you connect the GPS device to a computer with USB cable, a menu appears on screen for setting the USB Mode, as shown below.

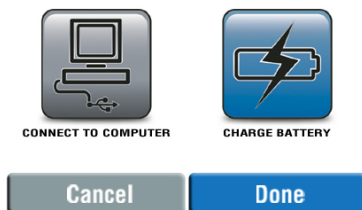

You can set the USB mode to determine how the device behave when it was connected to a computer.

CONNECT TO COMPUTER: Connect to computer for data accessing.

CHARGE BATTERY: Connect to computer for charging the battery.

Then tap to confirm or tap to cancel.

If you did not set any USB mode in 10 seconds after the menu appeared, the default mode will be CHARGE BATTERY.

Note: The USB cable is not included. In order to connect the computer, please prepare a USB Cable.

Using The Mounting Bracket

A suction cup mount is provided for attaching the GPS unit to the windshield or the dashboard.

Assemble the bracket and cradle as shown below and then attach the GPS to the cradle.



Fig. 1



Fig. 2

1. Fig. 1 Slide the mount cradle onto the end of the mount bracket. It will snap into place.
2. Fig. 2 Set the bottom edge of the GPS unit onto the mount cradle. Then push the upper tab of the mount cradle towards the GPS body to snap the tab into the back of the body. To remove the unit, gently pull the upper tab on the mount cradle away from the GPS body.
3. Raise the suction cup lever (see Arrow #2), press the suction cup to the windshield, then press down on the suction cup lever to secure the bracket to the windshield.
4. Lastly, rotate the cradle to adjust the GPS unit to proper position.

Note: Keep the suction cup and the interior of the windshield clean to ensure good adhesion.

If you prefer to mount the unit to the dashboard, you may use the adhesive disk

1. Choose a clean, flat spot on your dashboard.
2. Peel off protection liner from the back of the disk.
3. Attach the disk to your dashboard.
4. Using the suction cup, attach the bracket to the adhesive disk.

General Setup

System Main Menu

When in navigator, tap **Exit** button of the Navigation Menu to exit the application.

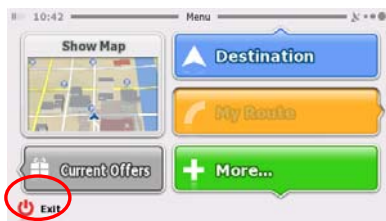



A confirmation message appears: Are you sure you want exit the program? Tap **Exit** and the system main menu appears.



In the main menu, there are four items for selecting. Touch the corresponding item to enter.

Tap  to enter the Navigator.

Tap  to enter the MP3 Player.

Tap  to enter the Photo Viewer.

Tap  to enter the Setup menu.

General Setup

Setup Menu



In the main menu, tap  **Setup** to enter the **Setup** menu, the screen will display as below:



In the Setup menu, tap  to return to the main menu.

Language



Tap  in the Setup menu to enter **Language** setting menu for language selection, as shown below:

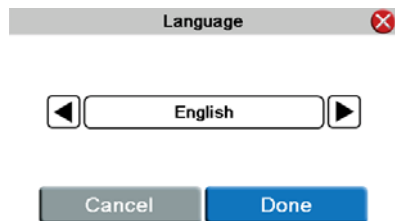

Tap the ,  buttons to select language.

Then tap  to confirm or tap  to cancel.



General Setup



Date & Time

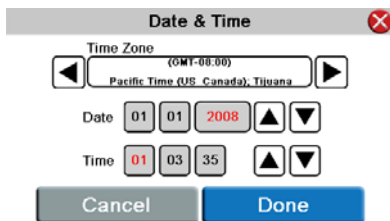



Tap **Date & Time** in the Setup menu to enter **Date & Time** setting menu for changing to the current time zone, date and time, as shown below:



Tap the   buttons to select the proper Time Zone.

Tap the   buttons of Date group to change the corresponding date.

Tap the   buttons of Time group to change the corresponding time.



Then tap  to confirm or tap  to cancel.



Brightness

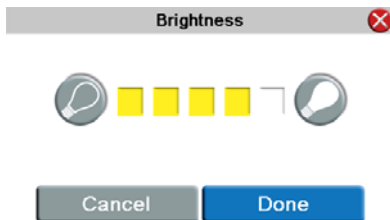

Tap **Brightness** in the Setup menu to enter **Brightness** setting menu for backlight adjustment, as shown below:



Tap   to darken or increase the brightness of the display.

After setting, tap  to confirm or tap  to cancel.

General Setup

Volume



Tap **Volume** in the Setup menu to enter **Volume** settings menu for volume adjustment, as shown below:

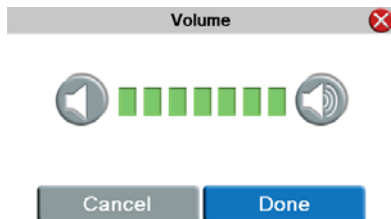

Tap the  to decrease the volume.

Tap the  to increase the volume.

Then tap  to confirm or tap  to cancel.

Align Screen



Tap **Align Screen** in the Setup menu to align the screen, as shown below.



Tap the center of the cross with your finger. When the cross moves to another position, tap and hold the center of the new target. Repeat each time to complete the calibration process. When tapping the screen on the final step, the new settings will be stored and you are returned to the Display menu.

General Setup

Power



Tap  in the Setup menu to enter **Power** menu, as shown below:

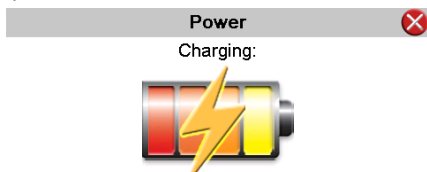

The Power menu displays the unit's battery status. The values are between 0% and 100%, where 0% means the battery power has run out completely, and 100% represents a full battery power. When the battery is being charged, the Battery Status will indicate "Charging".

Playing Music

The unit is designed with an SD card slot and supports MP3 and WMA format music files. To use the music player, you will need to have an SD card with your MP3 music files preloaded.

Please note that you cannot use the navigation function of the device at the same time you are using the music player. Remove the SD Mapping Data Card that comes with the device from the SD card slot on the side of the unit. Then insert your SD card with your MP3 or WMA music files.

Note: Please take special care of the Mapping Data Card if you remove it to use the Music Player as the navigation function will not work without it.

Warning: For your own safety, do not use the earphones when driving.

To Load Your Music

- First load your MP3 or WMA formatted music onto your personal SD card. Music files can be imported to your SD card on a PC, using a variety of programs such as Windows Media Player. This process must be performed independent of the navigation unit.
- Insert your SD card into the side of the GPS unit.

Do not attempt to use the unit to read and burn music files from an external source.

Playing Music



Tap **Music** in the system main menu to enter the Music Player, as shown below:

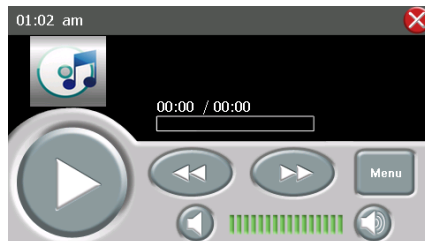



Playing Music

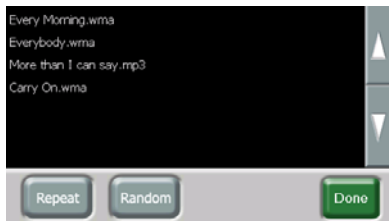

Tap  button to enter the music play list menu, as shown below:



When you open the play list, the system will look for audio files on its SD memory card and create a play list automatically.

If the play list consists of more than one screen, tap the up arrow for the previous page and the down arrow for the next page.



Tap  /  toggle buttons to determine whether the player will repeat the songs in the play list or not.

Tap  /  toggle buttons to determine whether or not to play the songs in the list randomly.

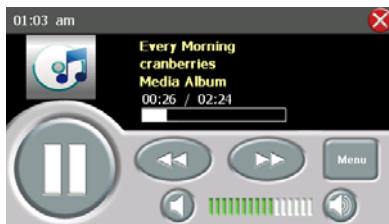
Tap  to start the playback and return to Music Player, as shown below.



Tap  toggle button to pause or resume the playback.

Tap  to go back to the previous song; tap  to skip to the next song.

Tap  ,  to decrease or increase the volume of the speaker.

Tap the progress bar  to select the desired playback starting point.

Tap  in the top right corner to exit.

Photo Viewer

The unit is designed with an SD card slot and supports JPEG format files playback. To use the Photo Viewer, you will need to have an SD card with your JPEG picture files preloaded. Please note that you cannot use the navigation function of the device at the same time you are using the Photo Viewer. Remove the SD Mapping Data Card that comes with the device from the SD card slot on the side of the unit. Then insert your SD card with your JPEG picture files.

Note: Please take special care of the Mapping Data Card if you remove it to use the Photo Viewer as the navigation function will not work without it.

If the unit lags when reading JPEG files, try using lower resolution files. We suggest 640 x 480 pixel resolution files.



Tap **Photos** in the system main menu to enter the Photo Viewer, as shown below:

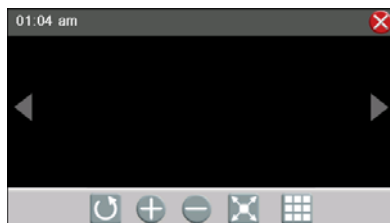

In the menu, tap  to enter the folder menu, as shown below:

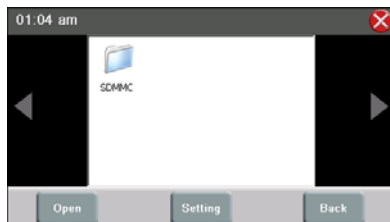
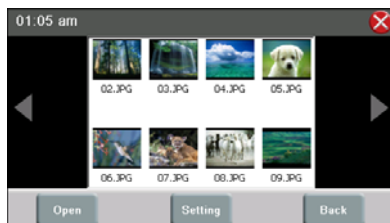



Photo Viewer

Viewing Photos

In the folder menu, double tap the memory card icon, and the photos stored in the memory card will be listed on the screen.



In the photo list, double tap a photo to display it on the LCD screen. You can also tap a photo to select it and then tap  to display it.

Tap  to return to the previous menu.

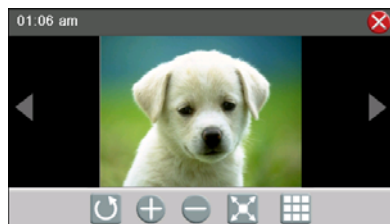

Tap  to enter the Setting menu for setting the Slide Show.

When playing photos, the Photo Viewer has following playback features:



Tap  to go back to the previous photo; tap  to switch to the next photo.

Tap  to rotate the photo.

Tap  ,  to zoom in or out of the photo.

Tap  to play the photo in full-screen mode; double tap the screen again to return to Photo Viewer.



Tap  to return to the photo list.

Photo Viewer

Using the slide show

Tap  in the photo list screen to enter the Setting menu for setting the Slide Show.



You can set the slide show on or off to determine whether or not to play photos in slide show mode. When the slide show is on, you can set the interval between two photos during slide show.

After setting, tap  to confirm or tap  to cancel.

Next, tap a photo in the photo list to open it.

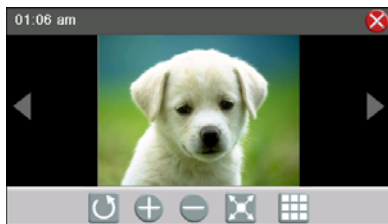

When you tap , the slide show will start.

To stop the slide show, double tap the screen.

Troubleshooting

Before contacting customer service, review the steps below to solve simple problems. If you still suspect something wrong with this unit, immediately turn the power off, disconnect the power connector from the unit, and contact Nextar Customer Service. Never try to repair the unit yourself.

Problem	Possible Cause	Possible Solution
Unit will not Power Up	Power adaptor is not connected properly	Check power adaptor connection <i>Note: Some automobile accessory power jacks provide no power when the ignition is off.</i>
	Weak battery	Charge battery

No Sound	Volume may be turned down or muted	Check volume and mute condition
Screen is difficult to see	Brightness may be turned down	Adjust brightness of the LCD screen

Navigator cannot receive satellite signals or does not orient	Unit may be inside a tunnel, inside a building, or tall buildings may obstruct the satellite signal	Check for obstructions
	Mapping SD card may be removed for music or photo functions	Re-install Mapping SD Card

Troubleshooting

Problem	Possible Cause	Possible Solution
Satellite signal strength is unstable. Comes and goes.	Rechargeable battery is weak	Plug in power adaptor and charge Battery
	Unit is moving side to side too much	Secure unit
	Signal is obstructed by buildings or other materials	Check and correct obstruction
	System software fails to function after entering a command	Turn the unit off and on again to reset using slide switch on rear.

Live Traffic data does not show on the screen	FM receiver is not connected to the main unit or power adaptor is not connected to the receiver.	Connect FM receiver to the main GPS unit and position antenna on the windshield. Plug in the power adaptor into the receiver unit.
	Vehicle is not in a metropolitan area that provides traffic coverage.	Check coverage map on Quick Start Guide or check online at www.navteq.com/rdstraffic

Other possibilities

Static or other external interference may cause the unit to function abnormally. In order to recover normal status, please unplug the power supply cord and then plug it into the outlet again to reset the unit. If the problems still exist, please cut off the power supply and consult your service center or a qualified technician.

Specifications

TFT screen size	4.3 inches
Frequency Response	20Hz - 20kHz
Audio Signal-to-noise Rate	$\geq 65\text{dB}$
Audio distortion + noise	$\leq -20\text{dB}$ (1kHz)
Channel Separation	$\geq 70\text{dB}$ (1kHz)
Dynamic Range	$\geq 80\text{dB}$ (1kHz)
Power	DC 5V
Power Consumption	< 8W
Dimensions	117mmX80mmX20mm (L*W*D)
Weight	About 0.17Kg

Design and specifications are subject to change without notice.

No part of this manual may be copied, republished, reproduced, transmitted or distributed in any way without prior written consent of Nextar, Inc. Any unauthorized distribution of this manual is expressly forbidden.

Nextar™, is a trademark of Nextar (Hong Kong) Limited.

Nextar may find it necessary to modify, amend or otherwise change or update this manual. We reserve the right to do this at any time, without any prior notice. All specifications and features are subject to change without notice.

Note: All screen shots shown are simulated and may not represent the actual screen on production unit sold to consumers.

For instruction books, information on this product, its operation and accessories, visit us on the web at: www.nextar.com

Or write to us at:

Nextar, Inc.
1661 Fairplex Drive
La Verne, CA 91750
USA

All products distributed by Nextar Inc. unless otherwise indicated
Made in China

© 2009 Nextar (Hong Kong) Limited. Nextar is a trademark and service mark of Nextar (Hong Kong) Limited. All other brand names, trademarks and service marks are property of their owners.



We are seriously concerned about environmental protection, and we hope that you share our concern as well. For more information regarding our recycling program, please visit us at <http://www.nextar.com/green> or call us at 1-888-849-0846